

AJH Course Selection

Incoming 7th & 8th Graders
2024-2025



Kind HEART. *Fierce* MIND. *Brave* SPIRIT.
WE ARE VIKINGS!

Our Viking Family

7th Grade AP:
Eric Finley



Principal:
Elisabeth Brodt



8th Grade AP:
Julie Schneller



7th Grade Counselor:
Vicky Mata



8th Grade Counselor:
Brianna Pollinger



7th & 8th Grade Promotion

To be promoted to 7th & 8th grade:

- You must have an overall average of 70 or higher in all courses.
- You must also have an overall average of 70 or higher in 3 of the 4 core subject areas:
 1. English and Reading
 2. Math
 3. Science
 4. Social Studies



promotion

Students who do not meet these requirements must either attend summer school or repeat your current grade.

Course Requests Overview

- ❖ Course Selections must be submitted online through SchoolLinks between February 5-February 19!
- ❖ A Course Planning sheet will be provided to students to help make placement decisions and will need to be turned into their ELA teacher by Wednesday February 7th.
- ❖ If you are moving or planning to move, you still must complete the course selection process
- ❖ If you are signing up for KAP classes, both the student and parent must read the KAP commitment letter on the back of the course selection sheet

See your Counselor if you have any questions.

Course Offerings for Current 6th graders
Adams Junior High 2022-2023

Due to ELA teacher by February 1, 2022

KATY

Parent/Guardian Name: Last, First, Middle Initial
Address: Street, City / Zip
Parent/Guardian Work Phone: _____

Student Name: Last, First, Middle Initial
Student ID Number: _____
City / Zip: _____

Parent/Guardian Cell Phone: _____

Use this list of courses as a guide to help you select your classes in Schoology. Each student must select one course from each of the required areas: English, Math, Science, Social Studies and PE. Students planning for 7th grade will select one elective course and students who qualify for 40% in ELA will select two elective courses and have one reading course. Students may not receive their first choice elective due to insufficient enrollment in a course, scheduling conflict, or over enrollment in course. Final placement into courses is contingent upon campus approval. (All placement requests are subject to have met specific Katy ISD screening criteria.)

REQUIREMENTS: CIRCLE one course from each of the required areas of English, Math, Science, Social Studies and PE. Select required courses by printing the course number for the course. **REQUIREMENTS: List five Elective choices in order of preference.** Student and parent signatures are required that all course guidelines have been reviewed and course selections have been made based on the student's individual interests, talents and commitments.

ENGLISH AND READING	SCIENCE	PE
ENR1 English Language Arts and Reading	SC10 SCIENCE 10 KAP	PE10 PE 10 - Boys
ENR2 English Language Arts and Reading	SC11 SCIENCE 11 KAP	PE11 PE 11 - Boys
ENR3 English Language Arts and Reading	SC12 SCIENCE 12 KAP	PE12 PE 12 - Boys
ENR4 English Language Arts and Reading	SC13 SCIENCE 13 KAP	PE13 PE 13 - Boys
ENR5 English Language Arts and Reading	SC14 SCIENCE 14 KAP	PE14 PE 14 - Boys
ENR6 English Language Arts and Reading	SC15 SCIENCE 15 KAP	PE15 PE 15 - Boys
ENR7 English Language Arts and Reading	SC16 SCIENCE 16 KAP	PE16 PE 16 - Boys
ENR8 English Language Arts and Reading	SC17 SCIENCE 17 KAP	PE17 PE 17 - Boys
ENR9 English Language Arts and Reading	SC18 SCIENCE 18 KAP	PE18 PE 18 - Boys
ENR10 English Language Arts and Reading	SC19 SCIENCE 19 KAP	PE19 PE 19 - Boys
ENR11 English Language Arts and Reading	SC20 SCIENCE 20 KAP	PE20 PE 20 - Boys
ENR12 English Language Arts and Reading	SC21 SCIENCE 21 KAP	PE21 PE 21 - Boys
ENR13 English Language Arts and Reading	SC22 SCIENCE 22 KAP	PE22 PE 22 - Boys
ENR14 English Language Arts and Reading	SC23 SCIENCE 23 KAP	PE23 PE 23 - Boys
ENR15 English Language Arts and Reading	SC24 SCIENCE 24 KAP	PE24 PE 24 - Boys
ENR16 English Language Arts and Reading	SC25 SCIENCE 25 KAP	PE25 PE 25 - Boys
ENR17 English Language Arts and Reading	SC26 SCIENCE 26 KAP	PE26 PE 26 - Boys
ENR18 English Language Arts and Reading	SC27 SCIENCE 27 KAP	PE27 PE 27 - Boys
ENR19 English Language Arts and Reading	SC28 SCIENCE 28 KAP	PE28 PE 28 - Boys
ENR20 English Language Arts and Reading	SC29 SCIENCE 29 KAP	PE29 PE 29 - Boys
ENR21 English Language Arts and Reading	SC30 SCIENCE 30 KAP	PE30 PE 30 - Boys
ENR22 English Language Arts and Reading	SC31 SCIENCE 31 KAP	PE31 PE 31 - Boys
ENR23 English Language Arts and Reading	SC32 SCIENCE 32 KAP	PE32 PE 32 - Boys
ENR24 English Language Arts and Reading	SC33 SCIENCE 33 KAP	PE33 PE 33 - Boys
ENR25 English Language Arts and Reading	SC34 SCIENCE 34 KAP	PE34 PE 34 - Boys
ENR26 English Language Arts and Reading	SC35 SCIENCE 35 KAP	PE35 PE 35 - Boys
ENR27 English Language Arts and Reading	SC36 SCIENCE 36 KAP	PE36 PE 36 - Boys
ENR28 English Language Arts and Reading	SC37 SCIENCE 37 KAP	PE37 PE 37 - Boys
ENR29 English Language Arts and Reading	SC38 SCIENCE 38 KAP	PE38 PE 38 - Boys
ENR30 English Language Arts and Reading	SC39 SCIENCE 39 KAP	PE39 PE 39 - Boys
ENR31 English Language Arts and Reading	SC40 SCIENCE 40 KAP	PE40 PE 40 - Boys
ENR32 English Language Arts and Reading	SC41 SCIENCE 41 KAP	PE41 PE 41 - Boys
ENR33 English Language Arts and Reading	SC42 SCIENCE 42 KAP	PE42 PE 42 - Boys
ENR34 English Language Arts and Reading	SC43 SCIENCE 43 KAP	PE43 PE 43 - Boys
ENR35 English Language Arts and Reading	SC44 SCIENCE 44 KAP	PE44 PE 44 - Boys
ENR36 English Language Arts and Reading	SC45 SCIENCE 45 KAP	PE45 PE 45 - Boys
ENR37 English Language Arts and Reading	SC46 SCIENCE 46 KAP	PE46 PE 46 - Boys
ENR38 English Language Arts and Reading	SC47 SCIENCE 47 KAP	PE47 PE 47 - Boys
ENR39 English Language Arts and Reading	SC48 SCIENCE 48 KAP	PE48 PE 48 - Boys
ENR40 English Language Arts and Reading	SC49 SCIENCE 49 KAP	PE49 PE 49 - Boys
ENR41 English Language Arts and Reading	SC50 SCIENCE 50 KAP	PE50 PE 50 - Boys
ENR42 English Language Arts and Reading	SC51 SCIENCE 51 KAP	PE51 PE 51 - Boys
ENR43 English Language Arts and Reading	SC52 SCIENCE 52 KAP	PE52 PE 52 - Boys
ENR44 English Language Arts and Reading	SC53 SCIENCE 53 KAP	PE53 PE 53 - Boys
ENR45 English Language Arts and Reading	SC54 SCIENCE 54 KAP	PE54 PE 54 - Boys
ENR46 English Language Arts and Reading	SC55 SCIENCE 55 KAP	PE55 PE 55 - Boys
ENR47 English Language Arts and Reading	SC56 SCIENCE 56 KAP	PE56 PE 56 - Boys
ENR48 English Language Arts and Reading	SC57 SCIENCE 57 KAP	PE57 PE 57 - Boys
ENR49 English Language Arts and Reading	SC58 SCIENCE 58 KAP	PE58 PE 58 - Boys
ENR50 English Language Arts and Reading	SC59 SCIENCE 59 KAP	PE59 PE 59 - Boys
ENR51 English Language Arts and Reading	SC60 SCIENCE 60 KAP	PE60 PE 60 - Boys
ENR52 English Language Arts and Reading	SC61 SCIENCE 61 KAP	PE61 PE 61 - Boys
ENR53 English Language Arts and Reading	SC62 SCIENCE 62 KAP	PE62 PE 62 - Boys
ENR54 English Language Arts and Reading	SC63 SCIENCE 63 KAP	PE63 PE 63 - Boys
ENR55 English Language Arts and Reading	SC64 SCIENCE 64 KAP	PE64 PE 64 - Boys
ENR56 English Language Arts and Reading	SC65 SCIENCE 65 KAP	PE65 PE 65 - Boys
ENR57 English Language Arts and Reading	SC66 SCIENCE 66 KAP	PE66 PE 66 - Boys
ENR58 English Language Arts and Reading	SC67 SCIENCE 67 KAP	PE67 PE 67 - Boys
ENR59 English Language Arts and Reading	SC68 SCIENCE 68 KAP	PE68 PE 68 - Boys
ENR60 English Language Arts and Reading	SC69 SCIENCE 69 KAP	PE69 PE 69 - Boys
ENR61 English Language Arts and Reading	SC70 SCIENCE 70 KAP	PE70 PE 70 - Boys
ENR62 English Language Arts and Reading	SC71 SCIENCE 71 KAP	PE71 PE 71 - Boys
ENR63 English Language Arts and Reading	SC72 SCIENCE 72 KAP	PE72 PE 72 - Boys
ENR64 English Language Arts and Reading	SC73 SCIENCE 73 KAP	PE73 PE 73 - Boys
ENR65 English Language Arts and Reading	SC74 SCIENCE 74 KAP	PE74 PE 74 - Boys
ENR66 English Language Arts and Reading	SC75 SCIENCE 75 KAP	PE75 PE 75 - Boys
ENR67 English Language Arts and Reading	SC76 SCIENCE 76 KAP	PE76 PE 76 - Boys
ENR68 English Language Arts and Reading	SC77 SCIENCE 77 KAP	PE77 PE 77 - Boys
ENR69 English Language Arts and Reading	SC78 SCIENCE 78 KAP	PE78 PE 78 - Boys
ENR70 English Language Arts and Reading	SC79 SCIENCE 79 KAP	PE79 PE 79 - Boys
ENR71 English Language Arts and Reading	SC80 SCIENCE 80 KAP	PE80 PE 80 - Boys
ENR72 English Language Arts and Reading	SC81 SCIENCE 81 KAP	PE81 PE 81 - Boys
ENR73 English Language Arts and Reading	SC82 SCIENCE 82 KAP	PE82 PE 82 - Boys
ENR74 English Language Arts and Reading	SC83 SCIENCE 83 KAP	PE83 PE 83 - Boys
ENR75 English Language Arts and Reading	SC84 SCIENCE 84 KAP	PE84 PE 84 - Boys
ENR76 English Language Arts and Reading	SC85 SCIENCE 85 KAP	PE85 PE 85 - Boys
ENR77 English Language Arts and Reading	SC86 SCIENCE 86 KAP	PE86 PE 86 - Boys
ENR78 English Language Arts and Reading	SC87 SCIENCE 87 KAP	PE87 PE 87 - Boys
ENR79 English Language Arts and Reading	SC88 SCIENCE 88 KAP	PE88 PE 88 - Boys
ENR80 English Language Arts and Reading	SC89 SCIENCE 89 KAP	PE89 PE 89 - Boys
ENR81 English Language Arts and Reading	SC90 SCIENCE 90 KAP	PE90 PE 90 - Boys
ENR82 English Language Arts and Reading	SC91 SCIENCE 91 KAP	PE91 PE 91 - Boys
ENR83 English Language Arts and Reading	SC92 SCIENCE 92 KAP	PE92 PE 92 - Boys
ENR84 English Language Arts and Reading	SC93 SCIENCE 93 KAP	PE93 PE 93 - Boys
ENR85 English Language Arts and Reading	SC94 SCIENCE 94 KAP	PE94 PE 94 - Boys
ENR86 English Language Arts and Reading	SC95 SCIENCE 95 KAP	PE95 PE 95 - Boys
ENR87 English Language Arts and Reading	SC96 SCIENCE 96 KAP	PE96 PE 96 - Boys
ENR88 English Language Arts and Reading	SC97 SCIENCE 97 KAP	PE97 PE 97 - Boys
ENR89 English Language Arts and Reading	SC98 SCIENCE 98 KAP	PE98 PE 98 - Boys
ENR90 English Language Arts and Reading	SC99 SCIENCE 99 KAP	PE99 PE 99 - Boys
ENR91 English Language Arts and Reading	SC100 SCIENCE 100 KAP	PE100 PE 100 - Boys

Parent/Guardian Signature: _____ Date: _____
Student Signature: _____ Date: _____

Please be advised that scheduling conflicts may prevent your student from attending certain courses. Please contact your counselor for more information. Students who do not attend the STAAR and/or other school-sponsored activities will not be allowed to attend these courses. These courses will take the place of the student's elective course.

Parent/Guardian Signature: _____ Date: _____
Student Signature: _____ Date: _____

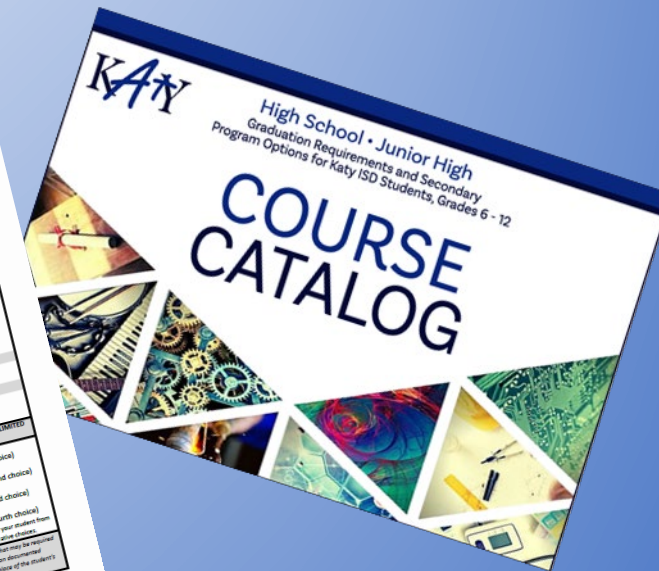

All students must sign up for the following courses:

- English
- Math
- Science
- Social Studies
- PE
- Elective(s) & alternate elective choices

* Available on AJH Counselor website

Choosing Courses

Three Class Format:

Academic – For everyone, on grade level, more time to review concepts, prepares students for college as well as other postsecondary education

KAP – More challenging, fast paced, prepares students for AP classes in high school *we recommend students have an “A” average in an Academic class

GT – Must be currently screened and identified

Choosing Courses

The decision to take academic or KAP should be made between you, your parents, and your teachers. Think about:

- ❖ Your interests and strengths
- ❖ How hard you are willing to work
- ❖ The grades you have earned in school and the kind of grades you like to make
- ❖ Motivation and attitude
- ❖ Standardized test scores
- ❖ Study habits
- ❖ Extracurricular activities and time commitments
- ❖ How quickly you catch on to new material

KAP PROGRAM INFORMATION



- Although we highly encourage students to stay in a KAP class, they may exit a course during the first 6-weeks grading period or at the end of the 1st semester.
- The student must have teacher and parent approval to exit.
- If the student's 6-weeks average falls below 70, the student will be placed into an Academic class at the end of the grading period unless otherwise recommended by the teacher.



The KAP Course Commitment form is included on the back of the course selection sheet.

Math for 7th Graders

6th, 7th, and 8th grade math classes are the foundations for high school math classes and should not be rushed.

Academic Math – on grade level curriculum

- ❖ Students will have math homework weekly to practice the concepts
- ❖ Students will learn 7th grade math skills/concepts only

KAP Math – accelerated math class covering the remaining ½ of 7th grade and all of 8th grade math curriculum

- ❖ A new concept is learned almost every day
- ❖ Students will have math homework every night to practice the concepts
- ❖ KAP math focuses on preparing students for High School Algebra 1 in 8th grade

* 7th grade KAP Math Students will take the 8th grade STAAR

- * Current high achieving students in 6th grade KAP Math can take a Credit By Exam (CBE) for 8th grade Math this summer (June/July testing windows). Students who pass the 8th grade Math CBE will be eligible to take Algebra in the 7th grade.
- * 6th Graders currently in ACA Math can choose to take 7th Grade KAP Math in 7th Grade. It is highly recommended to attend Math Bridge Program over the summer to teach missed concepts from 6th Grade KAP Math. (more details coming closer to summer)

Math for 8th Graders

6th, 7th, and 8th grade math classes are the foundations for high school math classes and should not be rushed.

❖ *Academic Math* – on grade level curriculum

- ❖ Students will have math homework weekly to practice the concepts
- ❖ Students will learn 8th grade math skills/concepts only

❖ *Algebra 1* – High School credit math class covering Algebra 1 curriculum

- ❖ A new concept is learned almost every day
- ❖ Students will have math homework every night to practice the concepts
- ❖ Students will receive HS credit upon completion of the course

* 8th grade Algebra 1 students will take the Algebra 1 EOC

* Current high achieving students in 7th grade Aca Math can take a Credit By Exam (CBE) for 8th grade Math this summer (June/July testing windows). Students who pass the 8th grade Math CBE will be eligible to take Algebra in the 8th grade.

KAP Math for 6th-8th Grade

KAP is the compacting of the junior high curriculum from 3 years to 2 years so that your child would be able to take Algebra I (a high school credit class) by 8th grade.

By taking your first high school math class in junior high, this frees up your child's senior year, to choose to take AP calculus, AP statistics, or other dual credit college credit math classes.

ELA-R, Science, and Social Studies

- ❖ The difference in academic and KAP for English Language Arts & Reading (ELA-R), Science, and Social Studies comes in the *resources/materials used and performance expectations*.
- ❖ KAP is built upon the core academic curriculum and is designed to build student capacity to understand more rigorous content.
- ❖ KAP is designed to help prepare students for advanced courses in high school.
- ❖ KAP/ACA ELA-R classes are blocked in 7th grade (meaning it is 2 class periods in a row with the same teacher). 7th grade GT ELA-R and 8th grade KAP/GT/ACA ELA-R classes are only 1 class period long.

Possible Required Courses

These courses take the place of your elective class.

- ❖ Math Lab: designed to help refine math concepts and fill in gaps
- ❖ Strategic Reading: designed to help improve reading proficiency and comprehension

Placement may be mandatory as a result of KISD standards and graduation requirements.

STAAR results are used to determine placement in the above courses.

Electives

- ❖ 7th grade students will receive **1 elective** for the year
- ❖ 7th grade GT ELA-R students will receive **2 electives** for the year as the GT ELA-R course is only one class period long
- ❖ 8th grade students will receive **2 electives** for the year
- ❖ Please be aware that some electives require after school commitments.
- ❖ Electives have assignments & receive numeric grades.
- ❖ Due to the high demand of certain electives, placement in elective courses will be limited based on availability and is not guaranteed.

Elective Options



BEGINNING BAND

- No experience necessary! We will teach you everything you need to know.
- Directors will assist you in choosing the right instrument for you, after you choose band as your elective.
- Band students may participate in band AND athletics, pep squad, cheer, clubs, Sci-Oly, etc.
- There are only 2 after school rehearsals in Beginning Band.

BAND INSTRUMENTS

Flute

Oboe

Clarinet

Bassoon

Alto Sax

Trumpet

Horn

Trombone

Euphonium

Percussion

Tuba



First Year Orchestra

(0 Years Experience)

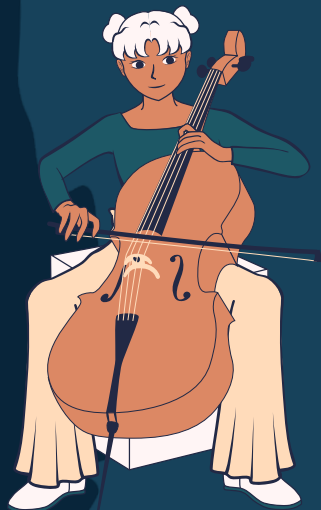

INSTRUMENTS WE OFFER:

Violin

Viola

Cello

Double Bass

- No experience necessary!
- We can help you find the right instrument for you.
- Instrument classes meet separately every day.
- Your daily homework is to practice your instrument!
- Andretti Karting & Games trip for FYO students.
- FYO Festival performance at MErrill Center and stop for lunch afterwards.



Performing Orchestra

(1 or more years of experience.)

- Performance-based course that builds on fundamental techniques and skills every year, from FYO and beyond.
- All orchestras perform a variety of music and presents several concerts throughout the year, including UIL music evaluations.
- Opportunity to perform in Region Orchestra Auditions and Solo & Ensemble Contest.
- Upper level ensembles will require weekly 45 minute sectionals in the morning.
- Students will audition for placement into a performing orchestra in April.

We host fun activities throughout the year!

- Instrument Wrap Party in December
- Andretti Karting & Games
- Waterpark Trip in May
- Outdoor games & picnic
- Movie Night in the Fall



7th/8th grade Choirs

Auditioned and Non Auditioned Choirs

Be a Part of the Viking Choir Family

- Solo and small group competitions
- Concerts
- Audition for Region Choir
- Social Events
- Sing in different languages
- Solo Opportunities
- Leadership Opportunities
- Learn how to read music
- Men and Womens' Classes
- End of Year Choir Trip
- End of Year Choir Banquet
- Pop Show and LOTS MORE!



Viking Theatre

Join us!



Find out more!



Foundations of Theatre

Acting

Dramatic Structure

Playwriting

Auditioning

Ensemble building

Characterization

Improvisation

Theatre history

Pantomime

Technical theatre

Professions in theatre

ALL Theatre classes touch on these topics at various degrees of complexity depending on the class level.

Earn points for:



INTERNATIONAL
THESPIAN SOCIETY

Points are earned based upon work done in productions & technical work as well as community service.

Theatre 2 & Theatre 3

- This class is for students who have successfully completed Theatre 1 and are interested in increasing their theatre skills. Further emphasis on acting skills, history of theatre, technical, and design work are explored.
- Students who are interested in furthering their acting or technical skills in front of a larger audience are encouraged to audition for the annual spring show, and to volunteer as ushers for our productions.
- After school participation for this course is not required, but encouraged.



Theatre 2/3 Production

Completion of Theatre 1 and an audition is required to be considered for this class. Packets and audition information are handed out at the beginning of March.



Perform in 3 shows a year:
Fall show, One-Act Play Contest, Spring Show

Students can act OR do tech (lights, sound, crew, stage management)

Rehearsal Requirements: 2-3 after school rehearsals + 2-3 Saturday rehearsals per show. We work around school sports for rehearsal schedules.

Eligibility: Students must be eligible to perform or take on a Technical role for a show. Theatre follows the no pass/no play rule.

Art 1 = Create, Grow, & have FUN!

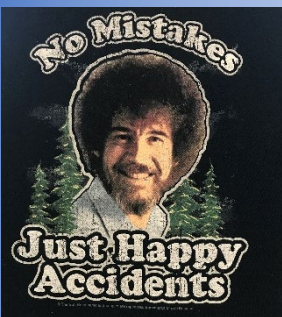

Paint, Draw + collaborate

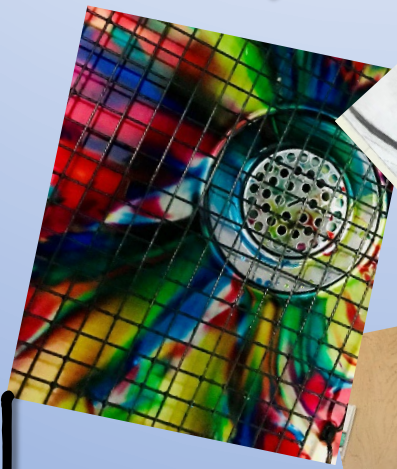
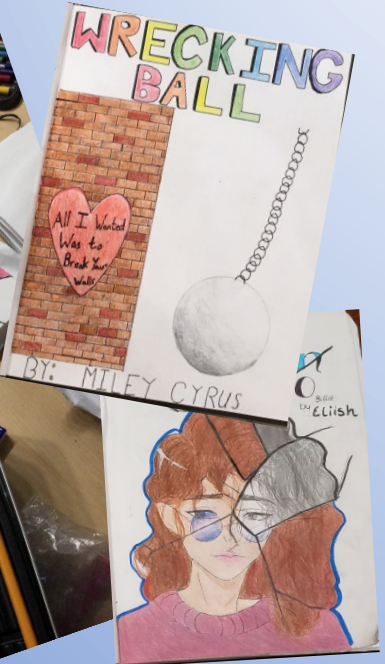

Sketchbook + skill development

Clay + 3d art

- ★ First Year Art Student (no art experience)
 - ★ Students create with the elements of art and principles of design in mind while building skills for a successful year in art.
- Just a sampling...we do so much more!

Art 2

Art we will create:

Drawing Basics

Painting

Ceramics

Sculpture

Mixed Media

Art History

Contests:

Scholastic Art Contest

Visual Art Scholastic Event

Houston Dog Show

Youth Art Month

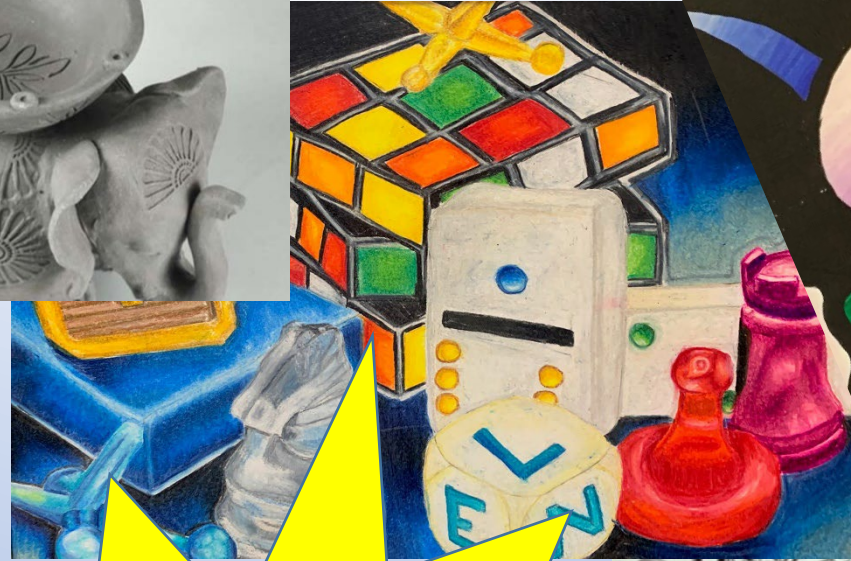

Join

PUBLICATIONS

TAKE PICTURES

WRITE STORIES

DESIGN THE
YEARBOOK!

ALL APPLICATIONS
ARE DUE BY FRIDAY,
MARCH 1



Publications (Yearbook) – Application Required!

If you like to take pictures, like to write, and enjoy socializing with others, Publications may be the elective for you!

- Open to students entering 7th or 8th grade
- Subject to an application process which includes letters of recommendations from current teachers
- Students will learn photography, marketing, yearbook design, and how to cover events that will be included in the Rune Stone Yearbook

Applications due by Friday, March 1st

Scan the QR code to
order!



Scan the QR code
to order your
yearbook and ad!

**ORDER YOUR
YEARBOOK**
and student ad
TODAY!

rune stone

Have you purchased your yearbook
yet?

Don't wait....we **SOLD OUT** last year!

What about a student recognition
ad?

Last day to purchase an ad is **2/8/24!**

Leadworthy

Leadership is not a position or title, it

Is action and example. In our

Class we are a

TEAM.



Leadworthy is based on the curriculum by Flip Flippen. You will discuss and learn about **first impressions**, **IPOSSESS skills**, **how to give a speech**, **you will look at yourself and how to present yourself to others**.

You will play games, role-play, and really get to know each other when you work as a TEAM.

This is a fun class that will help prepare you to take the mandatory speech class in high school.

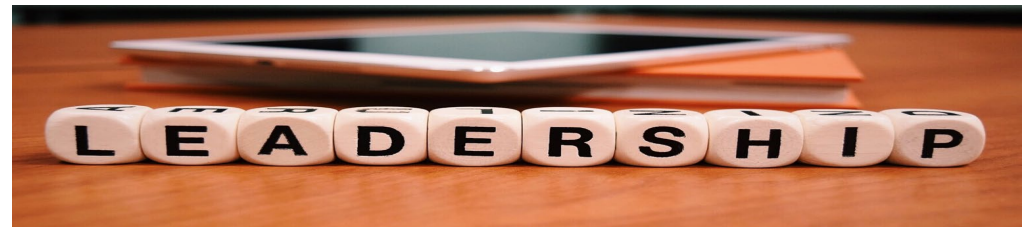

PEER ASSISTANT LEADERSHIP (PALS)

- This is a NEW elective next year
- For 8th graders who took LeadWorthy in 7th grade
- Students use their potential to make a difference
- Focuses on serving the school and community
- Will act as student leaders on AJH campus
- Application Required - scan the QR if you are interested in taking this class!

NEW!



Student Aide – 8th Grade Only

Must be approved by Administrator/Counselor

- Applications must be completed by March 10th via the google doc
- Incoming 8th grade students (current 7th graders) can apply to be a student aide as one of their elective choices. Students will be selected based on their application and teacher recommendations.
- Students who are selected as aides are helpful, respectful, and trustworthy. They must have good attendance and be passing all their classes. The student aides need to be positive representatives of our school. They must always behave appropriately and follow the student dress code.
- Student aides must be friendly, welcoming, and respect the confidentiality of our office.
- Student aides must be passing all classes and not have any N's or U's in conduct.
- Students are not eligible if they have been assigned I.S.S., been suspended from school, or received an attendance referral for excessive absences during the current school year.

Scan to access
the application
form



High School Credit Electives



★ HIGH SCHOOL CREDIT COURSES



- If you take a high school credit course in 7th or 8th grade, you **MUST NOT** request the same course in high school.
- You **CANNOT** repeat a course for which you have already earned credit.
- No credit is awarded for a duplicated course.
- Please make sure to choose HS credit classes carefully as once a grade is on their transcript it cannot be removed. Students enrolled in a HS credit course who are making below an 80% should seriously consider dropping the course to avoid any negative affects to their GPA in high school. You will not be able to drop after the 1st grading period.
- If the student does not pass the 1st or 2nd grading period or fails the 1st semester, he/she will automatically be dropped from the course per district policy.
- Regardless of the grade, no students will be removed from a HS credit course after the 1st semester.

All semester grades and grade points earned in high school credit courses become a permanent part of the student's high school transcript and are factored into the student's grade point average and class rank.

Career Launchpad

Compare Careers



Research three careers of interest to you, and complete the following table. Then complete the following Venn diagram to illustrate shared and different characteristics of each career.

#1	#2	#3
Job Title:		
Job Description (briefly summarize the job description here using bullet points)		
Average Salary:		
Educational Requirements:		

Career Launchpad

Subject: CTE

Eligible grades: 7th, 8th

Prerequisite: N/A

Corequisite: N/A

Students will explore and learn about the CTE Programs of Study offered in KISD through fun, hands-on projects and virtual job shadowing opportunities. Students will also be exposed to the soft-skills needed to be successful in tomorrow's workforce. Students will develop a resume and practice interviewing skills.

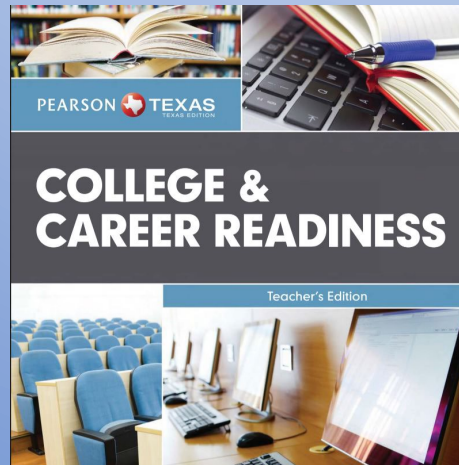

The 16 CAREER CLUSTERS

A Career Cluster is a grouping of occupations and broad industries based on commonalities

The slides will give you an understanding of each Career Cluster.

Unit 5 Paying for College

Unit 4 How Much Does College Cost?

Unit 3 How Do I Get In?

Admission to college can be competitive. If students create a plan to maximize their high school years, they increase their options for education beyond high school. There is no single path to college admission, but a well-thought-out plan will help students ensure that they have used their high school opportunities to maximum benefit.

The vocabulary of the college application process can be daunting. Students encounter the idea of GPA and transcripts, along with national standardized tests such as SAT and ACT. Extracurricular activities, both in and out of school, provide valuable learning and service opportunities for students. However, students need to remember to track their activities and awards in preparation for applying for both financial aid and admission.

States and local school districts set requirements for high school graduation, but many colleges require course work beyond basic requirements. These requirements can change from year to year. School counselors are a vital source of information about current graduation requirements.

Lesson Overview

Students will complete a graphic organizer during an interactive presentation about the factors that colleges consider during the admission process. Following the presentation, students will outline individual action items that will improve the likelihood of success in the college process. Instructors can extend the lesson by assigning students an admission essay.

Instructional Objectives

- Identify key factors that colleges consider in the admission process.
- Create individual action plan to optimize future choices and success.
- Define relevant terms used in the college application.

Business Information Management

7th & 8th Grade

***Dual Credit BIM available in high school**

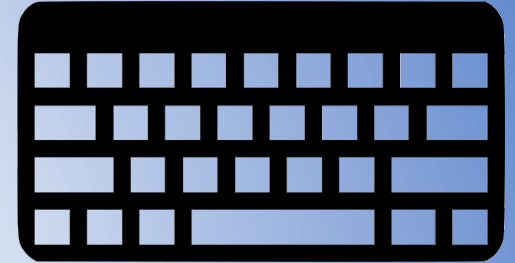

In Business Information Management, students will

- learn computer skills essential for college and work readiness using the industry standard Microsoft Office Suite
- produce a variety of Word documents, create Excel spreadsheets and charts, develop and maintain Access databases, and design professional PowerPoint presentations.
- Outlook is introduced as a necessary skill in college and work.

UNITS COVERED

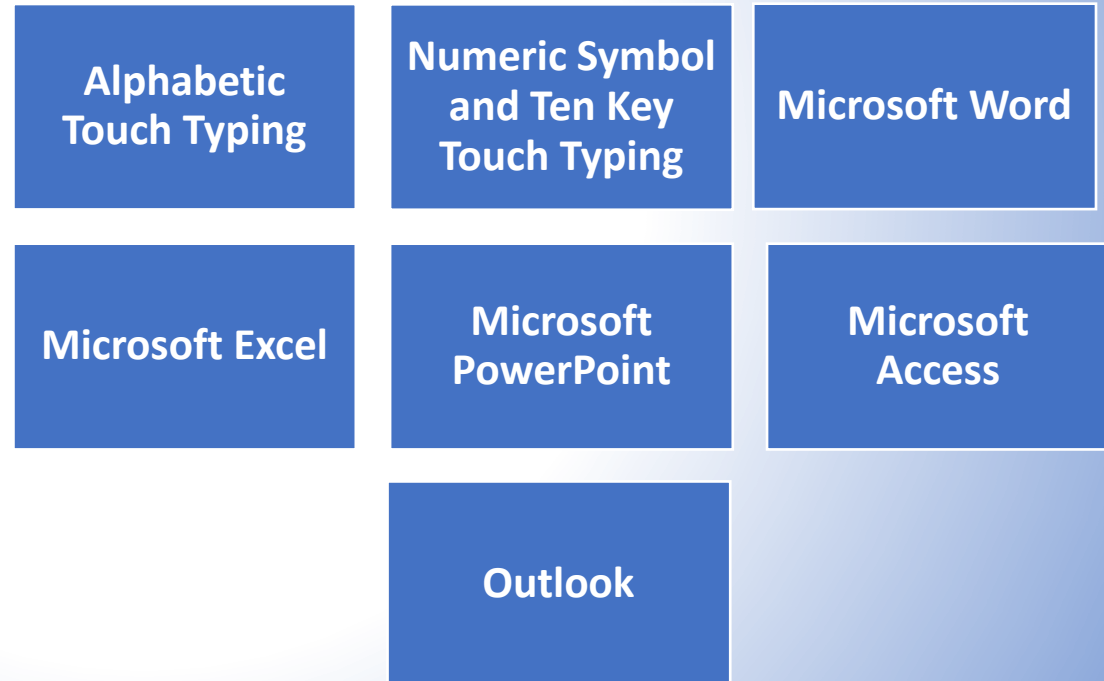

Principles of Arts, A/V Technology, and Communications

7th & 8th Grade

In Principles of Arts, A/V Technology and Communications, students will

- understand arts, audio/video technology, and communications systems.
- Within this context, students will be expected to develop an understanding of the various and multifaceted career opportunities in this cluster and the knowledge, skills, and educational requirements for those opportunities.

Pre-requisite for:

- *Audio Video Courses
- *Graphic Design
- * Digital Arts
- *Commercial photography
- *Animation
- *Fashion Design



UNITS COVERED

Audio Production	Video Production	Commercial Photography
Graphic Design	Animation	Fashion Design

Primarily a textbook based course

Spanish 1 – 8th grade only

- 8th Grade **Only** Course
- Covers all curriculum of Spanish 1 in a single year, just like in high school.
- Earn 1 full credit of high school in 1 year.
- **This is a course for non-native** Spanish speakers.
 - If Spanish is spoken at home, enroll in the **Spanish for Spanish Speakers** course instead.



Spanish for Spanish Speakers

8th grade only

- Esta clase es para estudiantes quienes su primer idioma es el español.
- Los estudiantes obtienen **2 créditos** por 1 año escolar en esta clase.
- Clase perfecta para estudiantes que lo **hablan** y quieren **aprender a escribir y leer** mejor, así como practicar el idioma en diferentes situaciones.
- **¡No tiene que ser experto en el idioma!**



Art 1 for High School Credit

Requirements: 8th Graders Only

Pre-requisite for all additional art classes

Art We Will Create:

Grid Drawing

Painterly Painting Techniques

Mixed Media

Ceramics

Sculpture

Sketchbook Fridays:

* Art Technique Practice

* Art History

* Experimenting with Art Methods

Contests:

Houston Livestock Show and Rodeo

Scholastic Art Contest

Visual Art Scholastic Event

Houston Dog Show

Youth Art Month

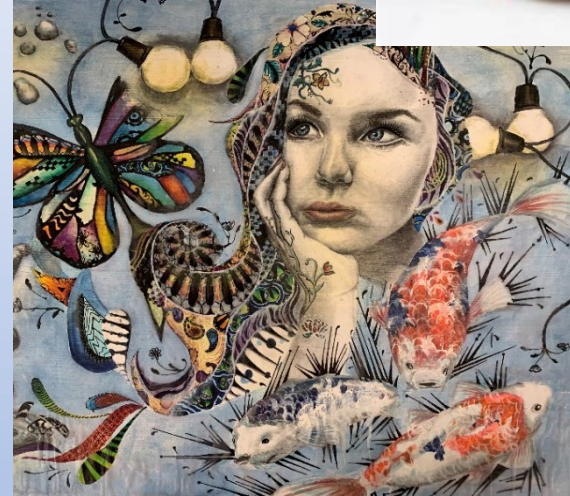

Come and
Join the
FUN!!

Principles of Information Technology

8th grade only

***Prerequisite for Networking Systems and Cyber Security (11th/12th grade courses)**

In Principles of Information Technology, students will

- develop computer literacy skills to adapt to emerging technologies used in the global marketplace.
- Implement personal and interpersonal skills to prepare for a rapidly evolving workplace environment.
- Enhance reading, writing, computing, communication, and reasoning skills and apply them to the information technology environment.



UNITS COVERED

Tech skills of the 21 st century	Computer hardware, operating systems and software	Word Processing
Career Exploration & Employability	Spreadsheets	Databases
Presentations	Programming	Web Design

Principles of Human Services

8th grade only



- Do you want to learn how to **manage money, cook, sew,** and learn the basics in **mental health, child development, and design?**
- Do you want to earn **high school credit?**
- Enroll in Principles of Human Services and learn the skills for life!



Principles of Applied Engineering – 8th grade only

Pre-requisite for all additional engineering classes

Principles of Applied Engineering

Subject: CTE

Eligible grades: 8th

Prerequisite: N/A

Corequisite: N/A

Course Fee: \$60.00 per year

Students use a variety of computer hardware and Autodesk applications to complete assignments and projects to gain an understanding of the interrelationships between various fields of science, technology, engineering, and mathematics. It is highly recommended that students take Algebra I so that they can follow the concurrent pathway.
Course Fee: \$60.00 per year.

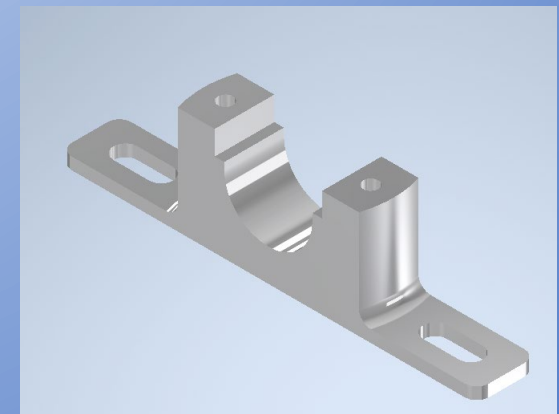
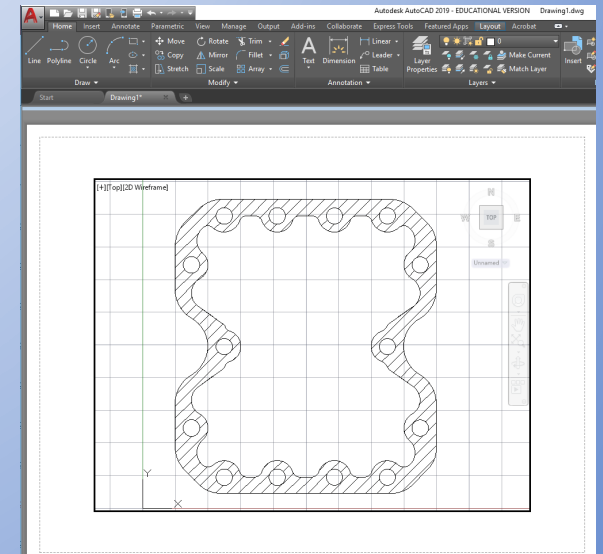
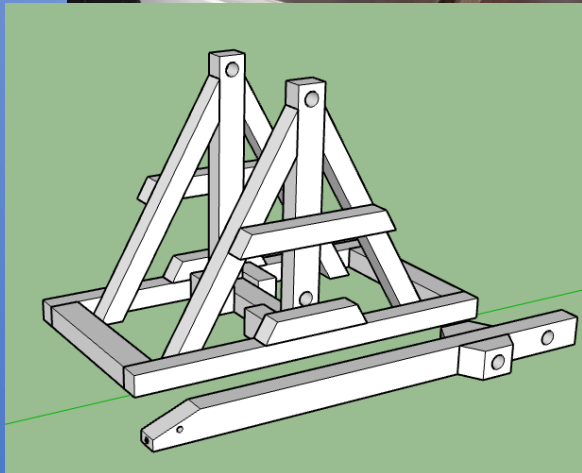
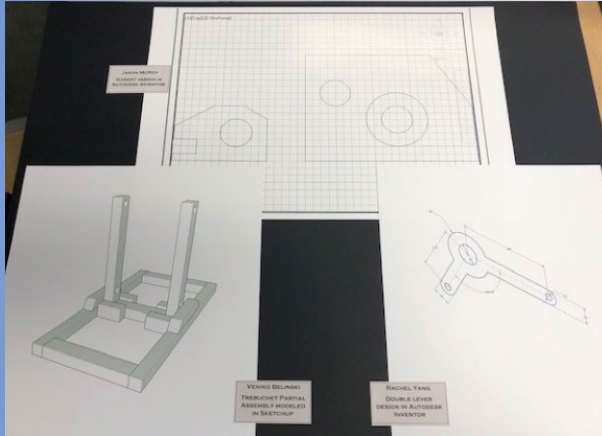

P.E. & P.E. Waivers

□ P.E.

□ All students will be enrolled in a Physical Education class

□ Both boys and girls (separate gyms)

Graded class/attend everyday

Dress out in uniforms: bring your own athletic shoes & socks

Lockers in locker room

Students will pay a \$15 fee at the beginning of the year for their PE uniform, locker, and laundry service.

□ Off Campus P.E.

□ Off Campus P.E. forms will not be accepted until August 1, 2024 through the first week of school in the front office.

□ If you participate in an approved individual sport for less than 15 hours per week, you will receive Study Hall as your replacement class.

□ If you participate in an approved individual sport for 15 or more hours a week you will leave campus after 7th period. These students will sign themselves out daily at the attendance window.

□ Forms should be printed from the AJH counselor website or the Katy ISD website.

□ Information and applications can be found at: [Health & Physical Education Curriculum / Off Campus PE \(katyisd.org\)](#)

Dance for 8th Graders

□ Dance

- Available to all 8th grade students

- Counts as PE course

- Graded class/attended every day

- Class is based on availability

 - If the course does not make, students will be placed in a regular PE class

- Takes place during 1st period with Dance director at Jordan HS

 - Students in Athletics will not be able to participate since 8th grade Athletics is 1st period also

 - Dance teacher will pick students up at 8:55 a.m. from AJH and walk them over to JHS for the class

 - Class takes place in JHS dance studio

 - Students will be brought back to AJH at the end of 1st period in time to make it to their 2nd period class

- Does not count as a high school credit PE course. This is a junior high credit class that allows our students the opportunity to explore the JHS dance program

Athletics

- ❖ Based on tryouts at the end of your 6th and 7th grade school year
- ❖ Coaches determine placement into athletics
- ❖ Must have physical on file dated after May 1, 2024 & RankOne online forms completed
- ❖ Athletic period (Fall) sports:
 - ❖ Football
 - ❖ Volleyball
 - ❖ Basketball
- ❖ After school (Spring) sports not placed in the athletic period:
 - ❖ Track
 - ❖ Soccer
 - ❖ Tennis
- ❖ Please see the coach if you are interested in playing a sport in 7th or 8th grade
- ❖ Coaches will give the counselors a list of students to be scheduled into the athletic period later this semester

Athletics is only for football, volleyball, and basketball.

No one is exclusively in athletics for the other 3 sports.

Remember: UIL "No Pass, No Play" is in effect – any grade below 70 on the report card will prevent participation.

Course Selection

- ❖ The district is using a college and career platform call SchoolLinks. **Students will use SchoolLinks for the course selection process.** Course Selection Window is February 5-February 19.
 - ❖ Students can access SchoolLinks through MyKaty Cloud
- ❖ Every student will receive a course planning sheet to help make class placement decisions. You will use this to enter your courses into SchoolLinks and then **turn in the Course Planning Sheet to your ELA teacher by February 7th.**
- ❖ Circle one course from each required course areas:
 - ❖ 1 ELA-R
 - ❖ 1 Math
 - ❖ 1 Science
 - ❖ 1 Social Studies
 - ❖ 1 PE course
 - ❖ Elective Choice(s)
- ❖ For Electives, please list your choices in order of preference
- ❖ Online Course Selections must be completed by **February 19 in SchoolLinks**
- ❖ Course Planning Sheets are due to **ELA Teachers by February 7rd**

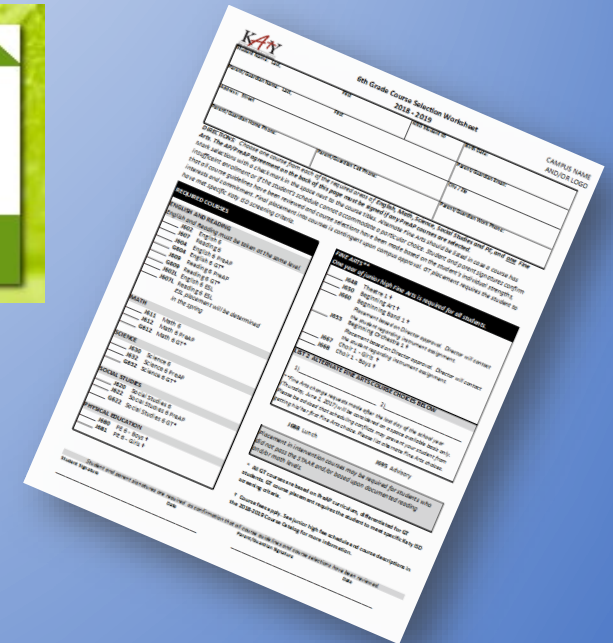
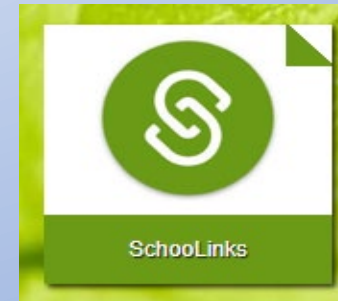

Course Catalogs

Katy ISD homepage

The screenshot shows the 'DISTRICT Course Catalog' page. The left sidebar contains a vertical menu with icons for various services: STUDENTS, CHECK-INS, ANALYTICS, DISTRICT, COLLEGES, CAREERS, FINANCES, ALUMNI, PROGRAMS, and ADMIN TOOLS. The 'DISTRICT' menu is expanded, showing options like Course Catalog, Course Planner, Personalized Plans, Event Scheduler, Experience Tracking, Scope and Sequence Verification, and Badges. The 'Course Catalog' option is highlighted with a blue arrow. The main content area is titled 'Overview' and includes links for 'About Katy ISD', 'Student Resources', 'Endorsements Overview', 'STEM Endorsement', 'Business and Industry Endorsement', and 'Public Service Endorsement'. A second arrow points to the 'Course offerings' dropdown menu at the bottom of the page.

On SchoolLinks

The screenshot shows the Katy ISD homepage. The top navigation bar is red and contains the 'KATY KATY INDEPENDENT SCHOOL DISTRICT' logo, a 'BOARD MEETING LIVE STREAM' icon, and several utility icons including HAC, MyKaty, and a lock icon. Below the navigation bar is a 'District Links' section with a list of links: Awards/Recognition, Board Election Results, Calendar, Child Find/504, District Data Dashboard, District Map, Financial Transparency, Frequently Access Pages, Handbooks, and Homeless Information. A blue arrow points to the 'Handbooks' link. To the right of the links is a large grey area with the text 'INC W NOT' partially visible.

Course Selection Process

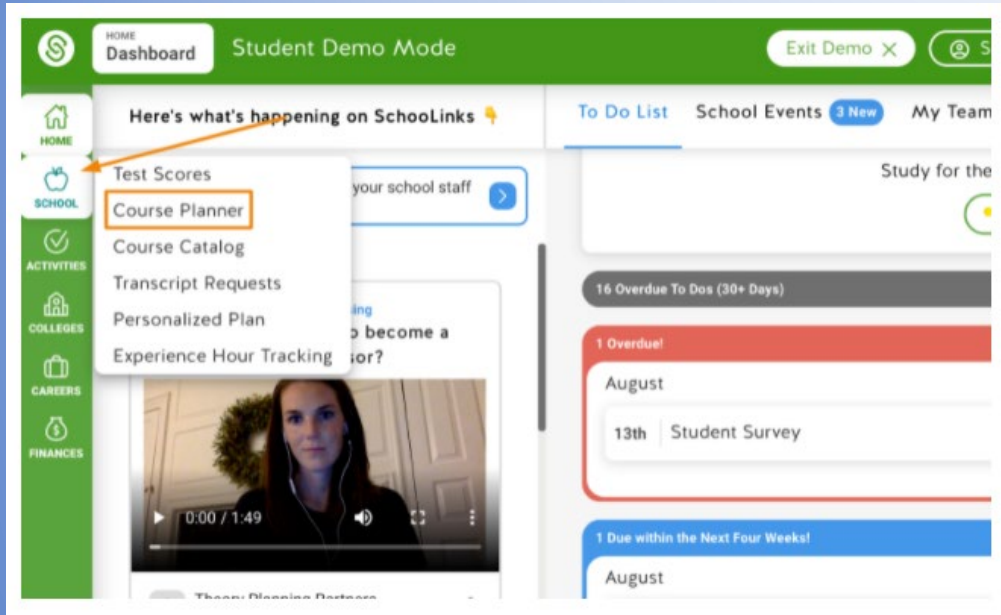

Input courses into SchoolLinks Course Planner by February 19



Use Course Planning Sheet to plan out courses. Turn into ELA Teacher by Feb 7th



Counselors will use this course planning sheet to Guide individual discussions with students in February.

KATY
Katy Independent School District

Course Offerings for Current 6th graders
Adams Junior High 2022-2023

Due to ELA teacher by
February 7, 2022

Student Name: Last, First	KSD Student ID	Birth Date:	
Parent/Guardian Name: Last, First		Parent/Guardian Email:	
Address: Street		City / Zip	
Parent/Guardian Home Phone:	Parent/Guardian Cell Phone:	Parent/Guardian Work Phone:	

Use this list of courses as a guide to help you select your classes in SchoolLinks. Each student must select one course from each of the required areas: English, Math, Science, Social Studies and PE. Students planning for 7th grade will select one elective course and students who qualify for GT in ELA will select two elective courses and have no reading course. Students may not receive their first choice elective due to insufficient enrollment in a course, scheduling conflict, or over enrollment in course. Final placement into courses is contingent upon campus approval. GT placement requires the student to have met specific Katy ISD screening criteria.

DIRECTIONS: CIRCLE one course from each of the required areas of English, Math, Science, Social Studies and PE. Mark required courses by circling the course number for the course. **IMPORTANT: List Fine Arts/Elective choices in order of preference.** Student and parent signatures confirm that all course guidelines have been reviewed and course selections have been made based on the student's individual strengths, interests and commitment.

REQUIRED COURSES - 7th Grade	ELECTIVE COURSES
ENGLISH AND READING	FINE ARTS
J706 English Language Arts and Reading Block 7	One year of junior high Fine Arts is required for all students. ALL Fine Art Placement is based on Director Approval
J726 English Language Arts and Reading Block 7 KAP	J911 Art 1 (6,7,8)
G726 English Language Arts and Reading Block 7 GT*	J912 Art 2 (7,8)
MATH	J921 Band 1 (6,7,8)
J711 Math 7	J922 Band 2 (7,8)
J714 Math 7 KAP	J931 Orchestra 1 (6,7,8)
G714 Math 7 KAP/GT*	J932 Orchestra 2 (7,8)
SCIENCE	J941 Theatre 1 (6,7,8)
J730 Science 7	J942 Theatre 2 (7,8)
J734 Science 7 KAP	J951 Choir 1 - Boys (6,7,8)
G734 Science 7 KAP/GT*	J952 Choir 2 - Boys (7,8)
SOCIAL STUDIES	J961 Choir 1 - Girls (6,7,8)
J720 Social Studies 7	J962 Choir 2 - Girls (7,8)
J724 Social Studies 7 KAP	CAREER AND TECHNOLOGY ELECTIVE COURSES
G724 Social Studies 7 KAP/GT*	J8560 Touch System Data Entry (7,8) (high school credit)
PHYSICAL EDUCATION	J2026 Web Communications (7,8) (high school credit)
J785 Athletics 7 - Boys	OTHER ELECTIVE COURSES
J786 Athletics 7 - Girls	J999 Leadworthy (7,8)
J780 PE 7 - Boys	J754 Career Investigation (7,8)
J781 PE 7 - Girls	J755 Publications 1 (7)
* GT course placement requires the student to meet specific Katy ISD screening criteria.	PLEASE LIST ELECTIVE CHOICE IN ORDER OF PREFERENCE - LIMITED SPACE AVAILABLE IN SOME COURSES
	1. _____ (first choice)
	2. _____ (second choice)
	3. _____ (third choice)
	4. _____ (fourth choice)
	**Please be advised that scheduling conflicts may prevent your student from getting his/her first elective choice. Please list alternative choices.
	Strategic Reading and Math Lab are intervention courses that may be required for students who did not pass the STAR and/or based upon documented reading and/or math levels. These courses will take the place of the student's PE or Elective.

Student and parent signatures are required as confirmation that all course guidelines and course selections have been reviewed.

Parent/Guardian Signature _____	Date _____	Student Signature _____	Date _____
---------------------------------	------------	-------------------------	------------

Verification Process

- Course Verification Window is March 18-26 and will take place in SchooLinks.
- Students/parents can check course requests through SchooLinks.
 - The course requests shown in SchooLinks are not the schedule — it is the list of courses you selected.
- All students will receive Course Verification Sheets After Spring Break. This is not a list of courses that y.
 - Students/parents review course selections on the Verification Sheets, cross through the course you are changing, and write the correct Course next to it.
- This is your last opportunity to make changes to your course requests.
- Course Verification sheets are due to ELA teacher Friday, March 22.
 - If we do not return a Course Verification sheet, we will assume that no corrections need to be made to your course selections.

AJH Counseling Website

All course selection information can be found here!

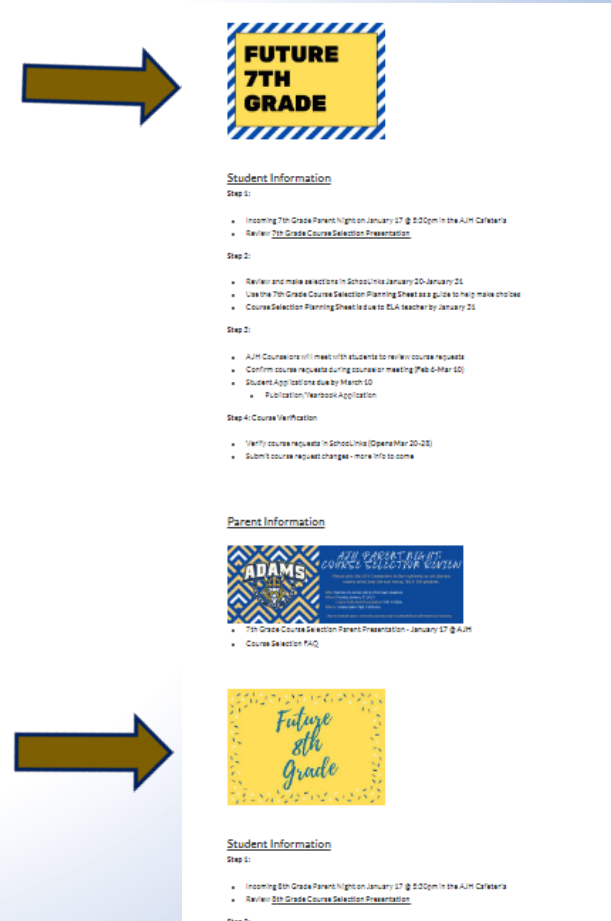
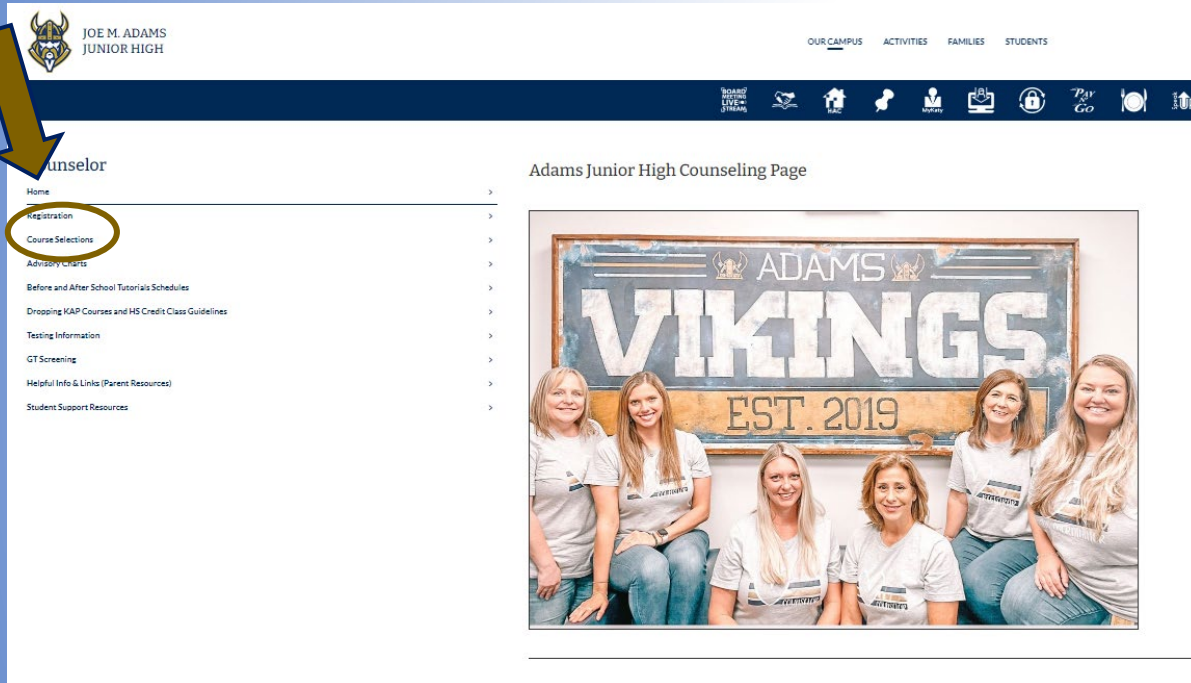

Scan the QR code to get to our website for more Course Selection Information

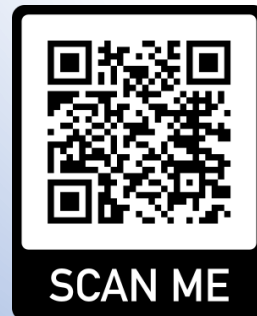

REMEMBER!

- Course selection submissions are due in SchooLinks by February 19
- Course selection sheets are due to ELA Teachers by February 7th
- Choose your courses wisely – think carefully about your choices.
- Talk to your teachers about KAP placement.
- Choose the elective that's most interesting to you.
- List alternate electives.
- Submit course requests on time!
- Any changes to course selections are made during the verification process. Course Verification Sheets due March 22.



QR Code Library

AJH Counseling Website



PALS Application
(current 7th graders only)



Publications (Yearbook)
Application



Student Aide Application
(current 7th graders only)



Course Catalog is
available in SchoolLinks

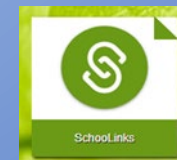

**We can't wait for
next year!**

